

Humble Homemade Hifi

high-grade do it yourself audio

loudspeaker crossover simulation example • 3-way loudspeaker
tweeter Model X • midrange Model Y • woofer Model Z

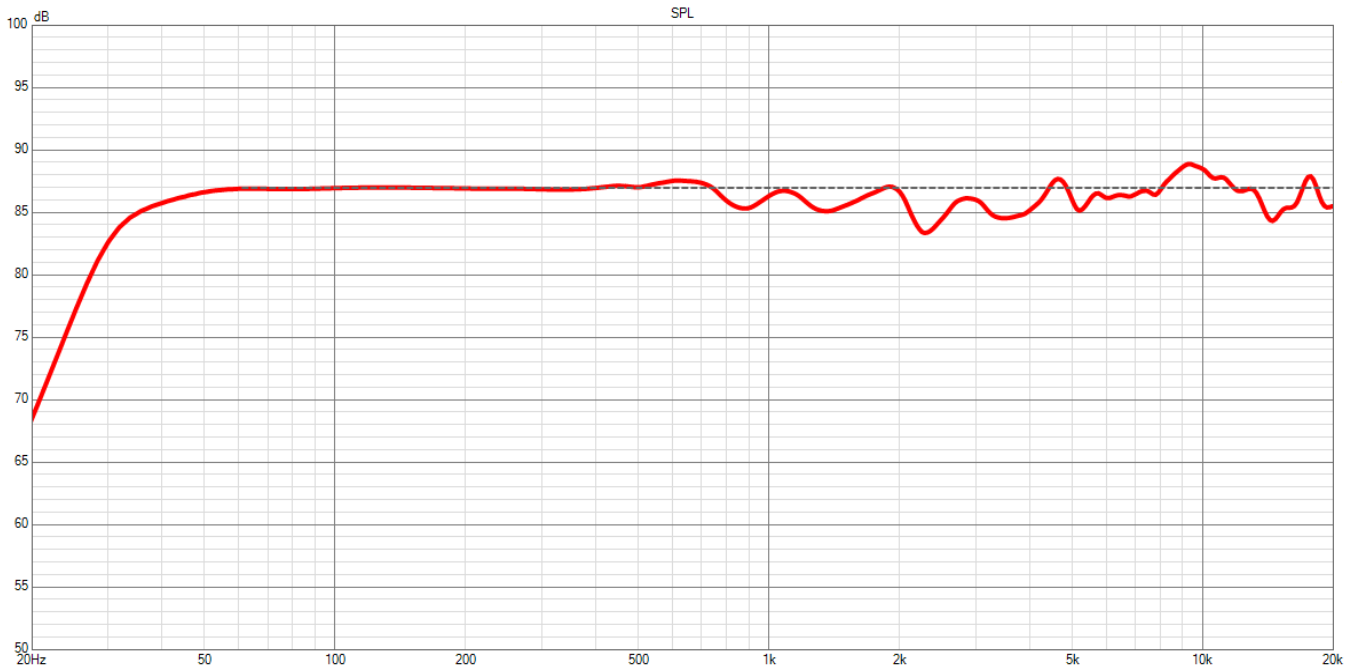

system frequency response

sensitivity: circa 87dB / 2.83V

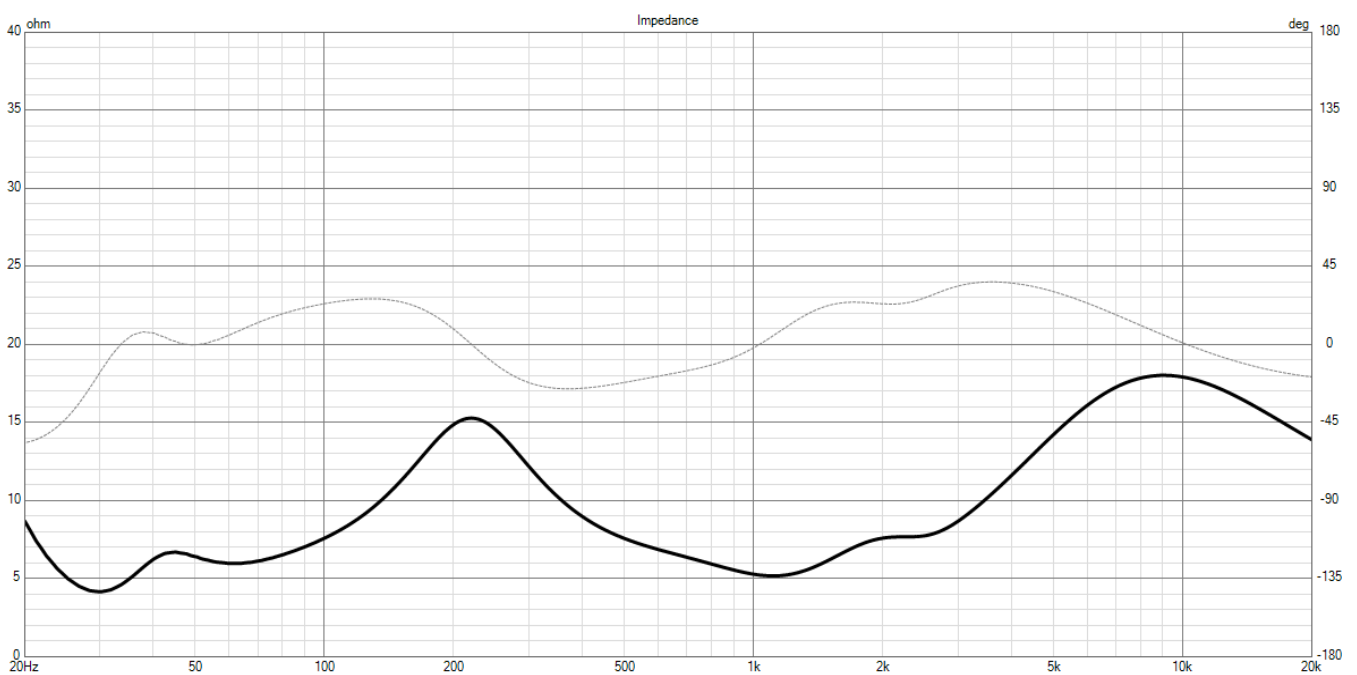

system impedance

nominal impedance: 6 ohms / impedance minimum: 4,2 ohms @30Hz

Humble Homemade Hifi

high-grade do it yourself audio

loudspeaker crossover simulation example • 3-way loudspeaker
tweeter Model X • midrange Model Y • woofer Model Z

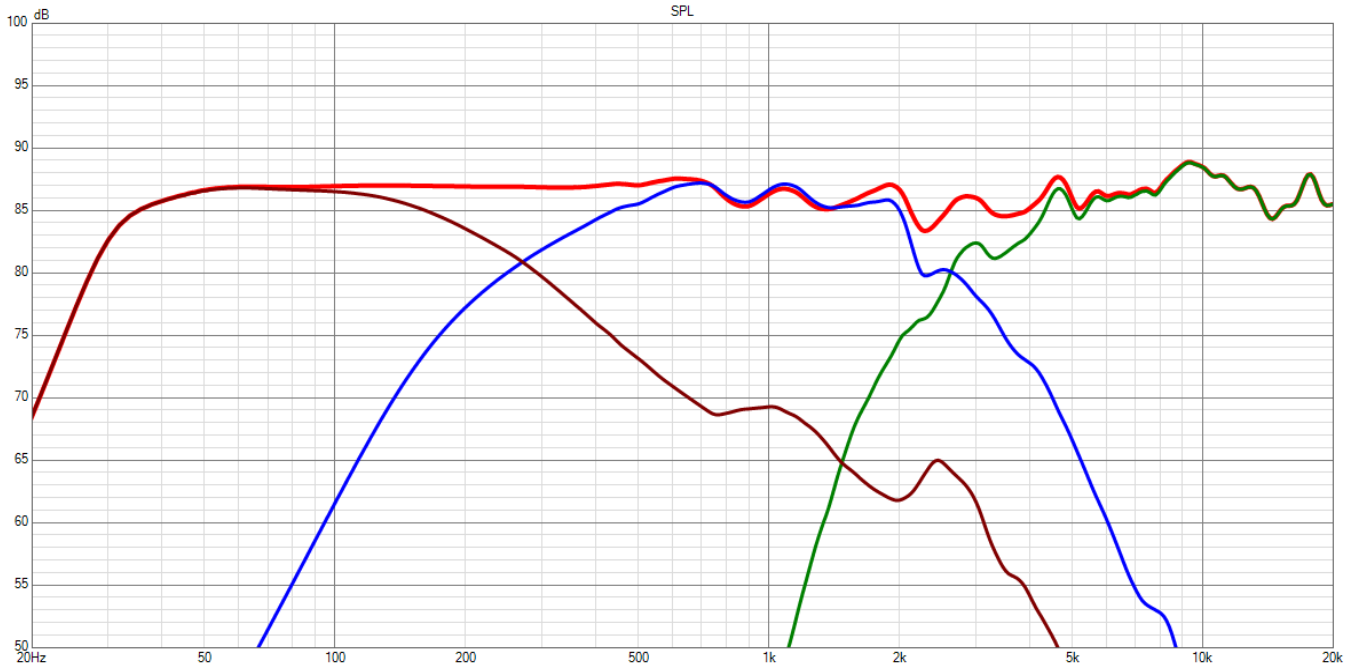

individual driver responses

acoustic crossoverpoints circa 280Hz and 2700Hz

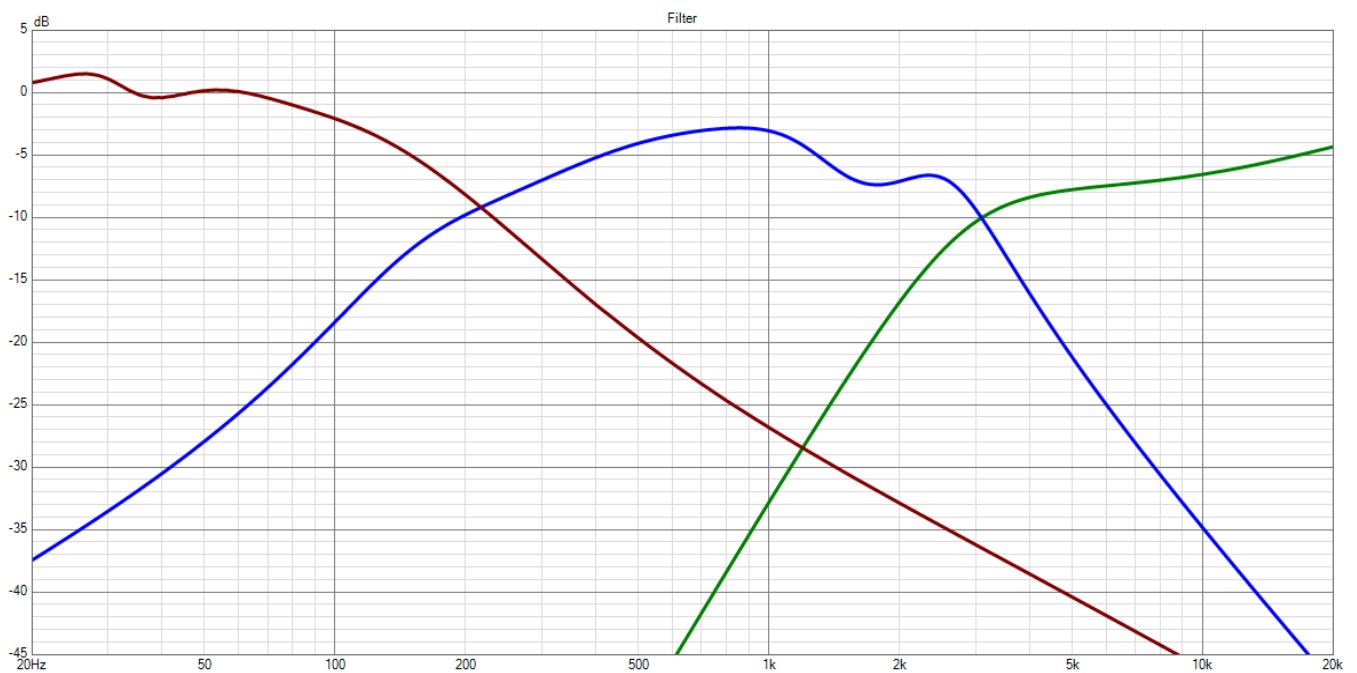

individual filter responses

electric crossoverpoints circa 220Hz and 3050Hz

Humble Homemade Hifi

high-grade do it yourself audio

loudspeaker crossover simulation example • 3-way loudspeaker
tweeter Model X • midrange Model Y • woofer Model Z

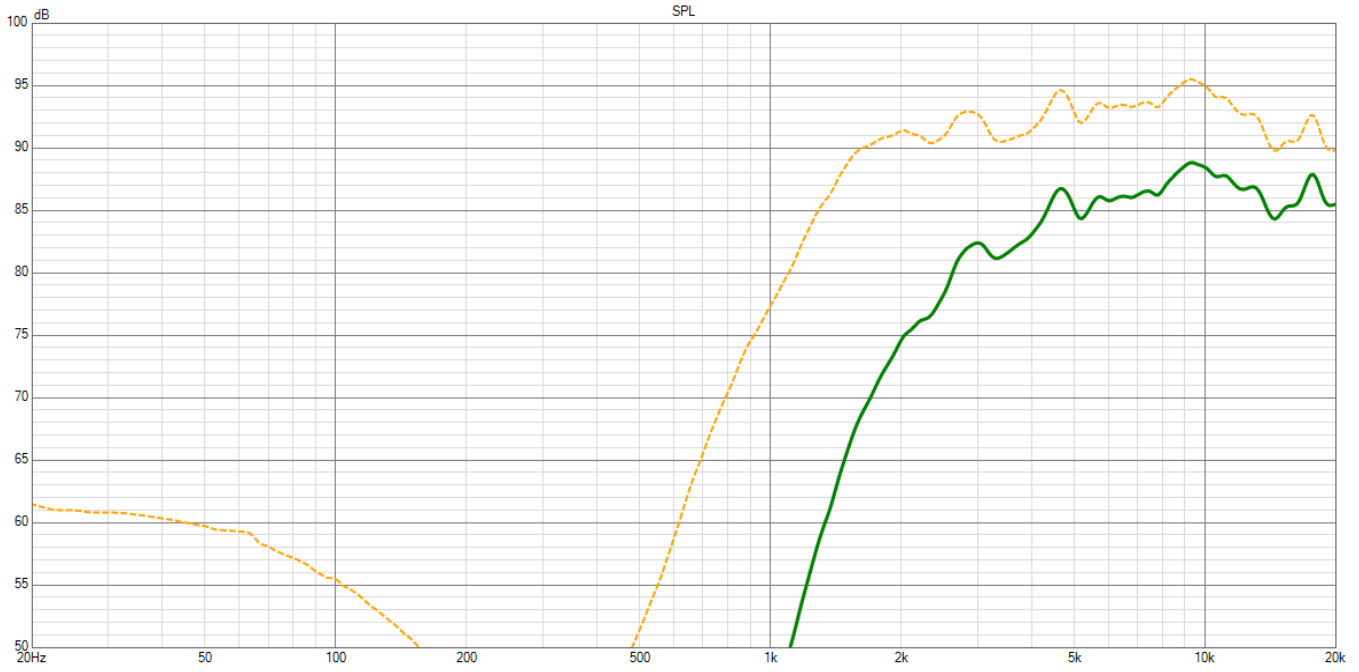

tweeter response with (green) and without crossover (yellow)

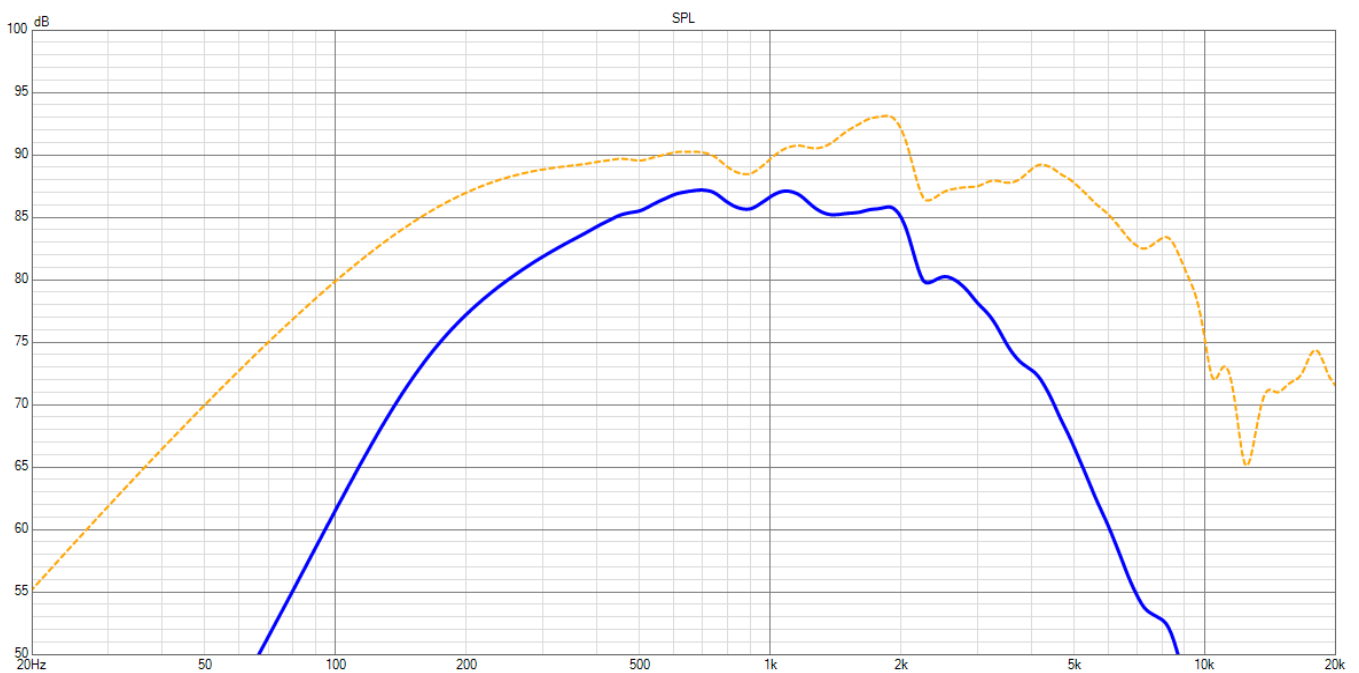

midrange response with (blue) and without crossover (yellow)

Humble Homemade Hifi

high-grade do it yourself audio

loudspeaker crossover simulation example • 3-way loudspeaker
tweeter Model X • midrange Model Y • woofer Model Z

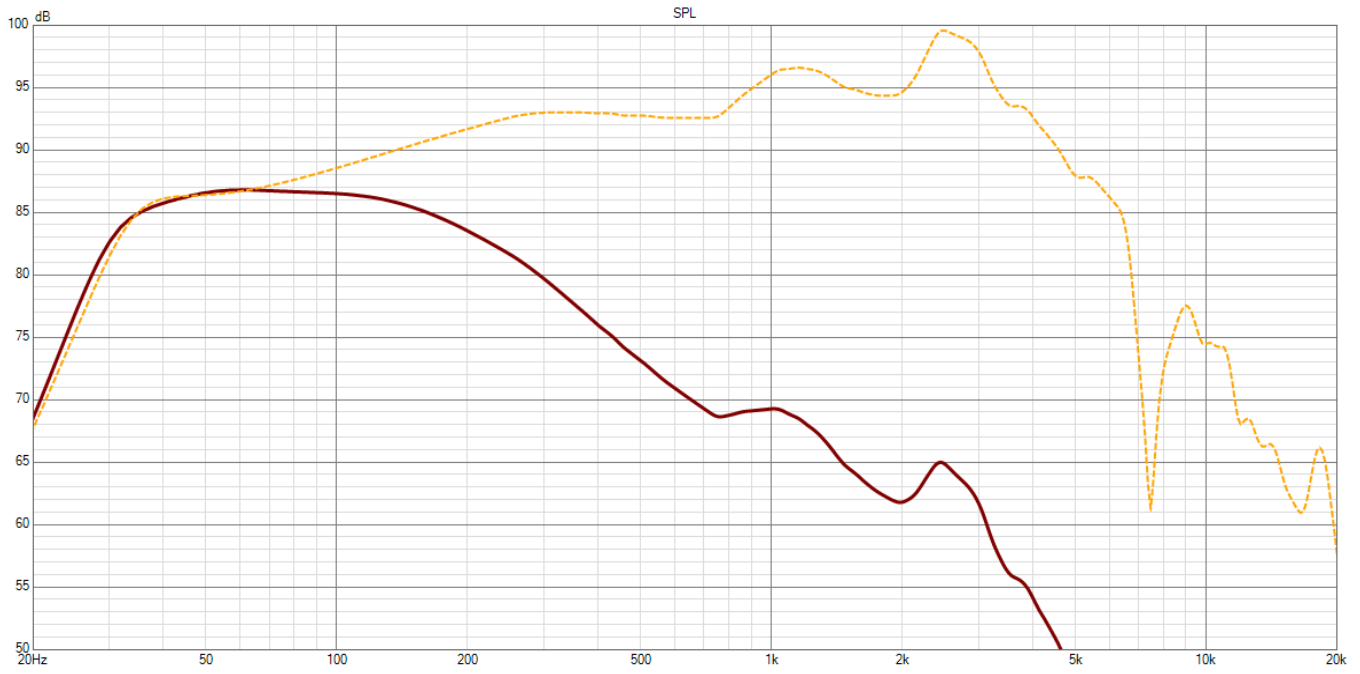

woofer response with (brown) and without crossover (yellow)

Humble Homemade Hifi

high-grade do it yourself audio

loudspeaker crossover simulation example • 3-way loudspeaker
tweeter Model X • midrange Model Y • woofer Model Z

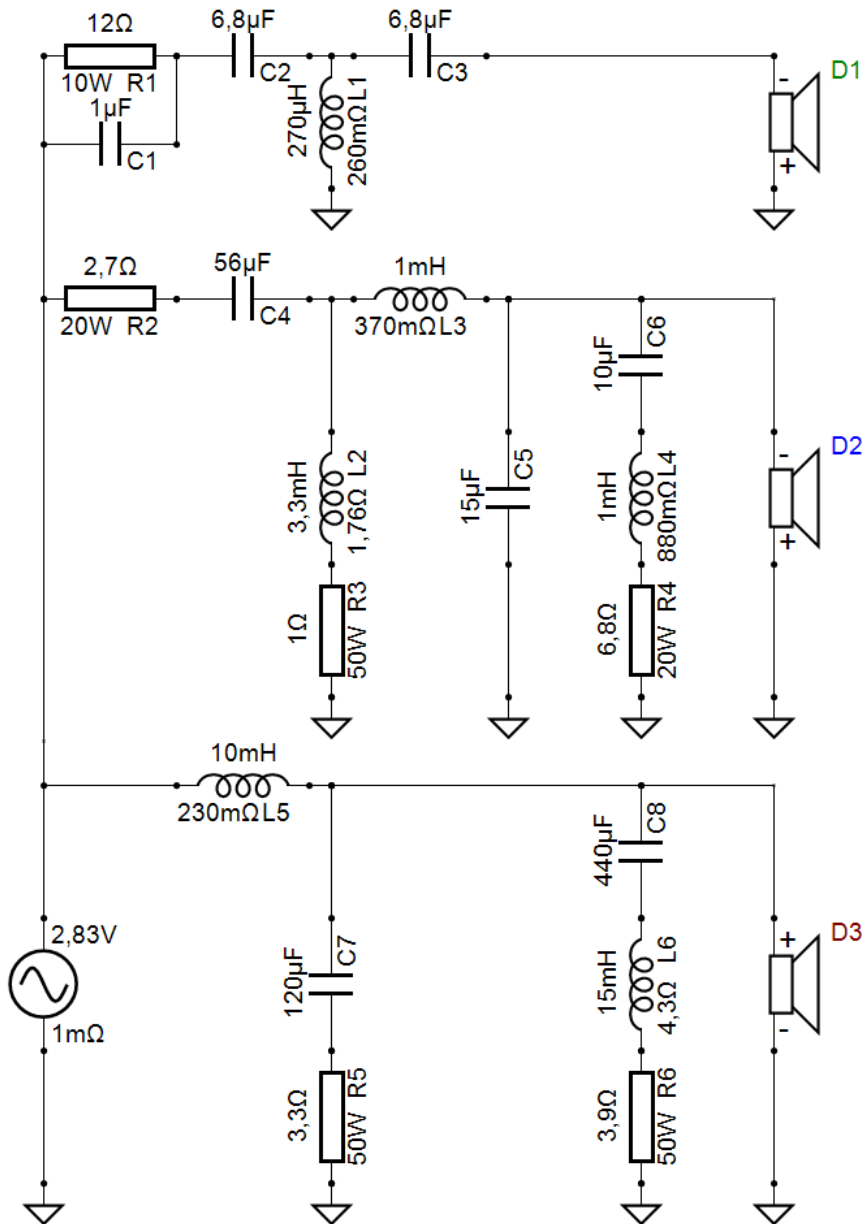

crossover schematic

tweeter level adjustable with resistor R1 (10 to 15 ohms)
midrange level adjustable with resistor R2 (2.2 to 3.3 ohms)
resistance R3 + DCR inductor L2 = circa 2.8 ohms
resistance R4 + DCR inductor L4 = circa 7.7 ohms
resistance R6 + DCR inductor L6 = circa 8.2 ohms